



ENA 8

快速參考指南 (中文)

首次使用ENA 8

所需用品:

- 咖啡豆(加入咖啡豆槽)
- 清水 (加進水箱)
- 奶管 (連接咖啡機與牛奶容器)

此快速參考指南並不代替《ENA 8 使用說明書》。請確保閣下首先讀畢與留意有關的安全資訊及提示，以免發生意外。

» 屏幕顯示«

水質硬度設定

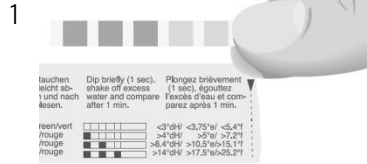

按 » < 與 » 圖示以選擇水質硬度

啟動濾芯系統

» Filter operation/ Insert filter (濾芯操作/ 插入濾芯)«

» OK (確認)«

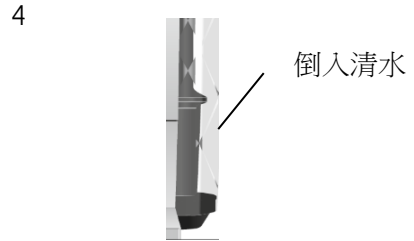

2 調校濾芯的延伸部分至合適的長度

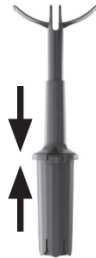

5 » Saved (儲存)«

» Filter is being rinsed (濾芯正在清洗中)«

3 插入濾芯

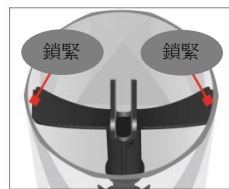

連接牛奶

移除奶泡器上保護膠蓋



連接牛奶管道

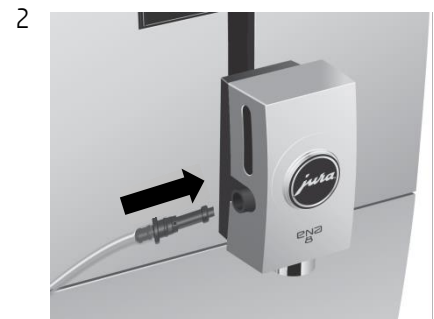

如何製作咖啡

所需用品：

- 咖啡豆（加入咖啡豆槽）
- 清水（加進水箱）
- 奶管（連接咖啡機與牛奶容器）

此快速參考指南並不代替《ENA 8 使用說明書》。請確保閣下首先讀畢與留意有關的安全資訊及提示，以免發生意外。

» 屏幕顯示 «



2 選擇咖啡：
按◀/▶旁邊的“-”鍵



3 按“O”以確認選擇



咖啡粉使用

1 掀起咖啡豆槽蓋

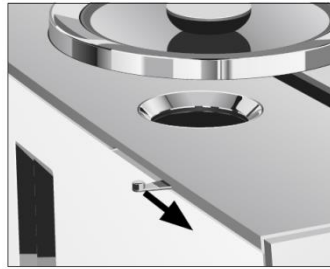

2 » Ground coffee (咖啡粉)« /
» Please add ground coffee
(請放入咖啡粉)«

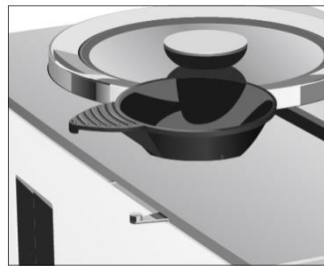

放置漏斗及加入咖啡豆（一匙）

3 按“O”鍵確認咖啡選擇



4 請享用



調校咖啡豆研磨器 (研磨粗幼)

轉動旋轉輪盤以改變咖啡粉粗幼(見下圖)

1 (左)至2 (右)：粗至幼

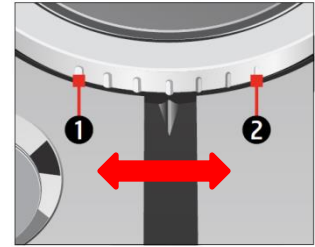

當咖啡研磨器正在運行時，扭至所需刻度(制作咖啡時)

永久更改個人化的飲品設定 (咖啡濃度/水量)

設定方法 1

按“P”旁的“-”鍵2秒以進入程序模式 - 1/2 產品設定

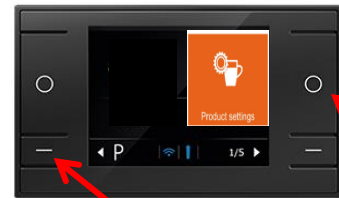

設定方法 2

設定方法 1

或

設定方法 2

按‘Coffee (咖啡)’旁的“O”鍵 2 秒
按‘Coffee strength (咖啡濃度)’ /
‘Volume (水量)’ 鍵
按◀/▶旁的“-”鍵以更改設定
按‘保存’

» Saved 保存 «



清洗奶泡系統

所需時間約2分鐘

所需清潔用品：
JURA 奶泡系統清潔劑



此快速參考指南並不代替《ENA 8 使用說明書》。請確保閣下首先讀畢與留意有關的安全資訊及提示，以免發生意外。

» 屏幕顯示«

清洗奶泡系統提示：
»Clean the milk system
(清洗奶泡系統)«



2 按“P”旁的“-”鍵 2 秒以進入程序模式 - 1/2 保養頁面

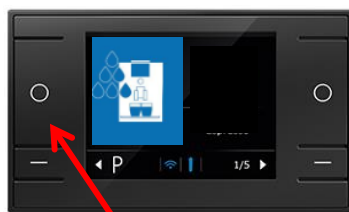

3 按 »Clean the milk system
(清洗奶泡系統)«

加入奶泡系統清潔劑與清水



連接奶管



6 按 » Start(開始)«
按 » Next(下一步)«

» Milk System is being cleaned
(奶泡系統正在沖洗中)«
» Fresh Water 清水«

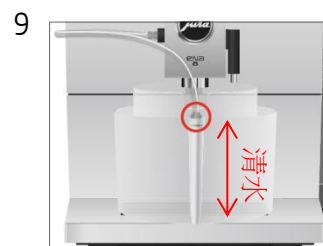

10 按 » Next 下一步«
»Milk System is being cleaned
(奶泡系統正在沖洗中)«

拆卸和清洗奶泡器 (深層清潔)

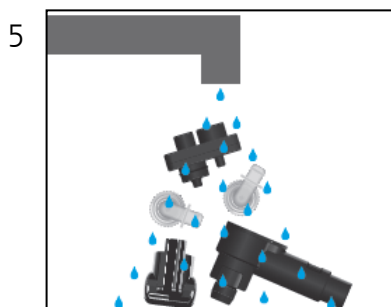
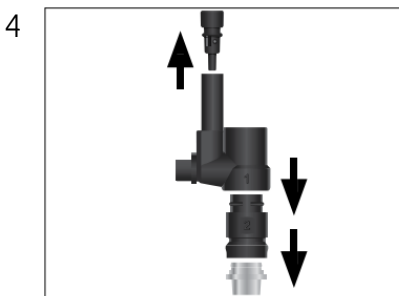
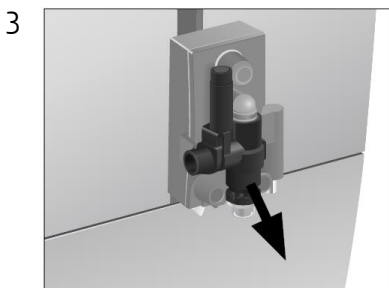
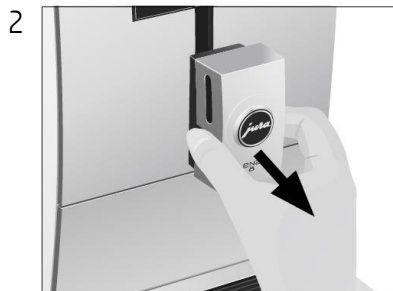
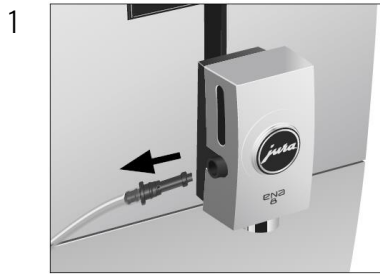

去除牛奶殘留下來的嚴重污跡

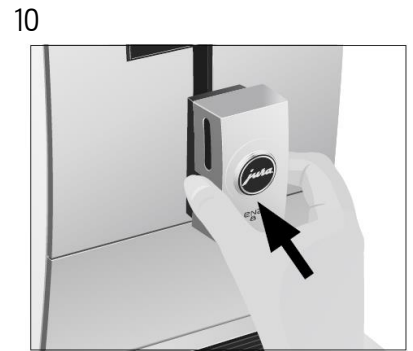
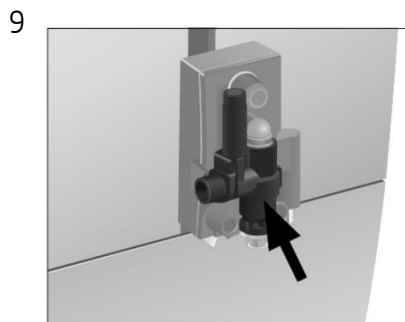
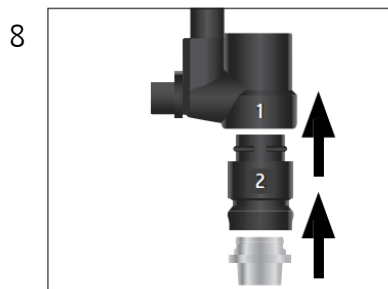
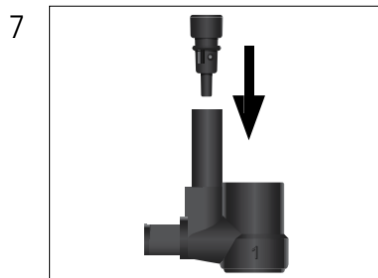

ENA 8

更換濾芯

所需時間約3-5分鐘

所需清潔用品：
JURA 濾芯系統
(智能/ 迷你智能)



此快速參考指南並不代替《ENA 8 使用說明書》。
請確保閣下首先讀畢與留意有關的安全資訊及提示，以免發生意外。

» 屏幕顯示 «



更換濾芯提示:

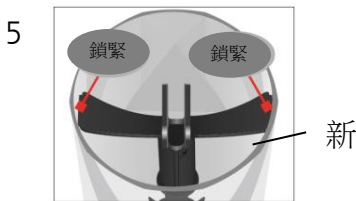
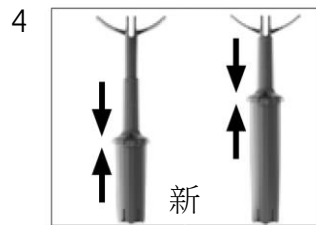
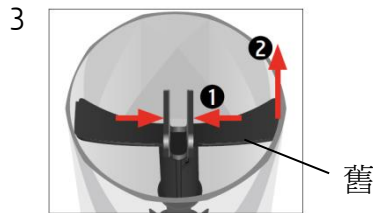
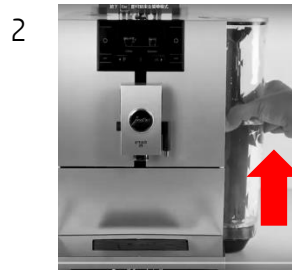

6 »Filter is being rinsed
(濾芯正在清洗中)«



水箱除垢

所需時間約40分鐘

若使用濾芯模式，將不會被提示進行水箱除垢。

所需清潔用品：
JURA雙效除垢藥片



此快速參考指南並不代替《ENA 8 使用說明書》。請確保閣下首先讀畢與留意有關的安全資訊及提示，以免發生意外。

» Display 屏幕顯示«

*將於數分鐘內完全溶解。

水箱除垢提示:

» Descaling the machine (咖啡機除垢)«



2 按“P”旁的“-”鍵2秒以進入程序模式 - 1/2 保養頁面



3 » Descale (除垢)« - 2/3
» Start (開始)«
» Next (下一步)«
» Empty drip tray 清空廢水盤«

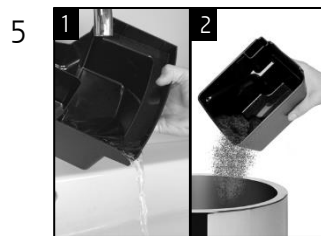

» Pour descaling agent* into empty water tank 將已溶解的除垢藥片溶液*放進水箱«

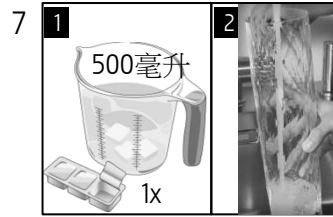

9 » Next (下一步)«
» Machine is being descaled (咖啡機正在進行除垢)«

10 重覆步驟4-6

» Rinse Water Tank (沖洗水箱)«

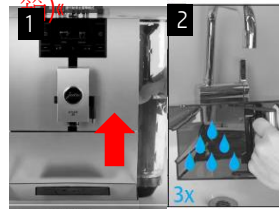

11 » Fill Water Tank (為水箱注水)«

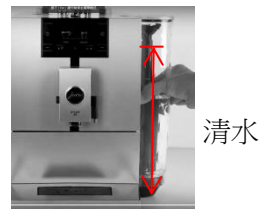

12 » Next (下一步)«
» Machine is being descaled (咖啡機正在進行除垢)«

重覆步驟4-6

清潔咖啡機

所需時間約20分鐘

所需清潔用品：
JURA 雙效清洗藥片



此快速參考指南並不代替《ENA 8 使用說明書》。請確保閣下首先讀畢與留意有關的安全資訊及提示，以免發生意外。

» 屏幕顯示 «

清潔咖啡機提示：

» Clean the machine
(清洗咖啡機)«



2 按“P”旁的“-”鍵2秒以進入程序模式 - 1/2 保養頁面

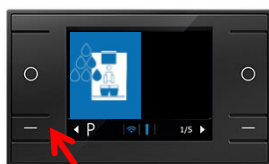

3

» Clean (清洗)«
» Start (開始)«
» Next (下一步)«

4 清空粉渣盒

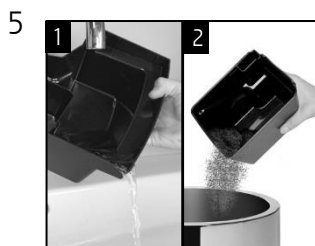

» Next (下一步)«
» Add cleaning tablet (加入清洗藥片)«

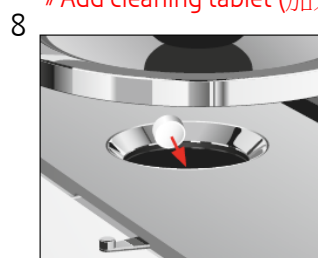

9

» Clean (清洗)«
» Start (開始)«
» Machine is being cleaned
(咖啡機正在進行清洗)«

重覆步驟4-6